

i

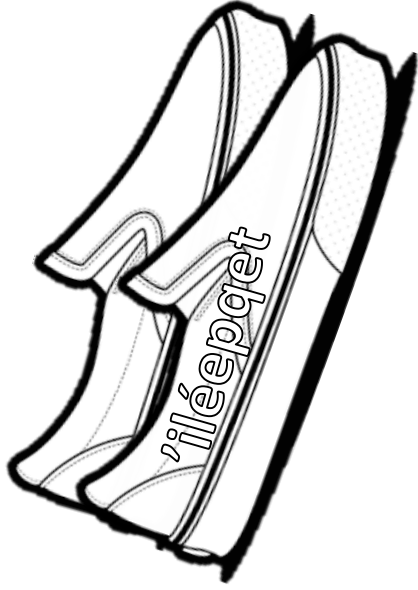

s

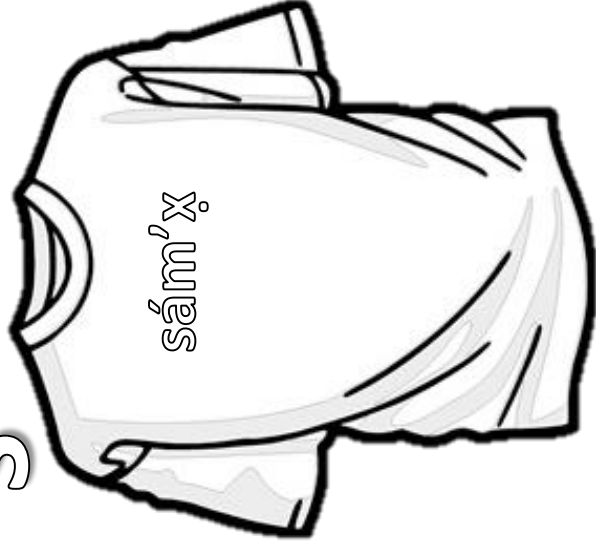

k

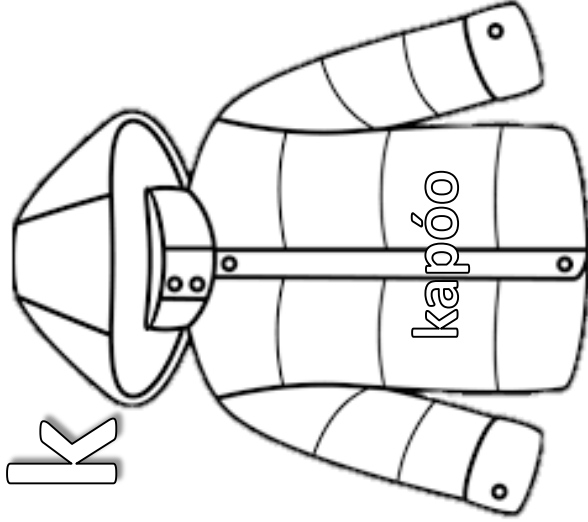

t

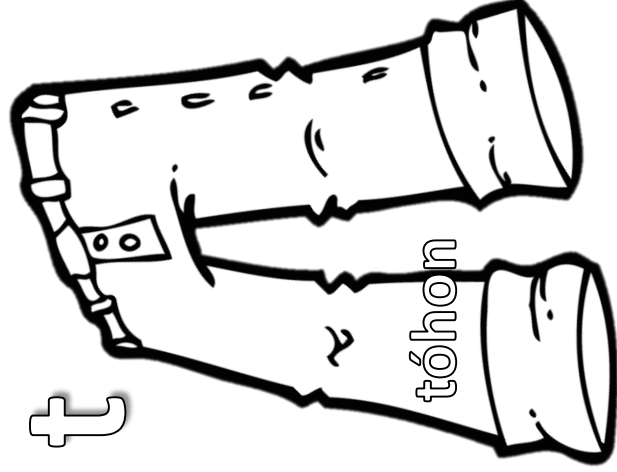

t

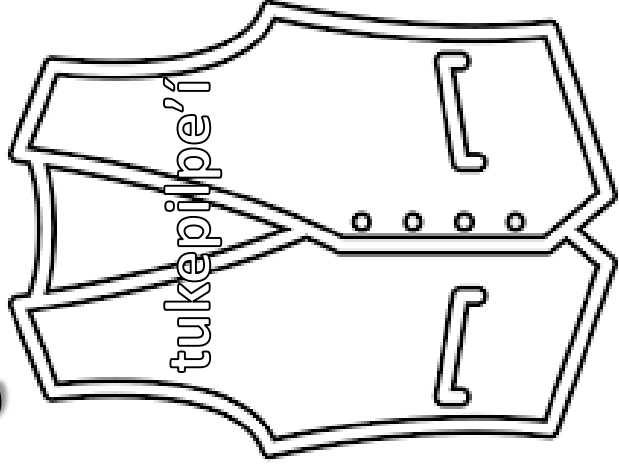

tukepipe'í

'i

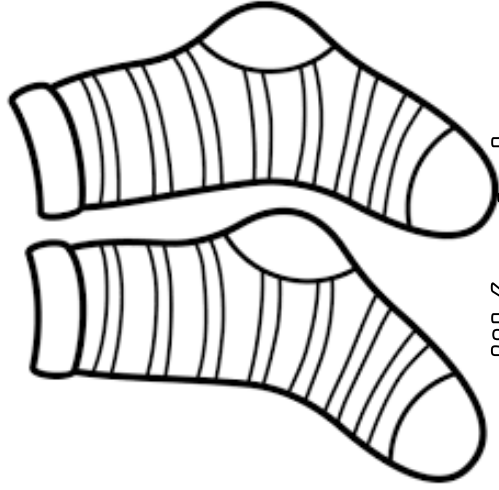

'iléeptekey

t

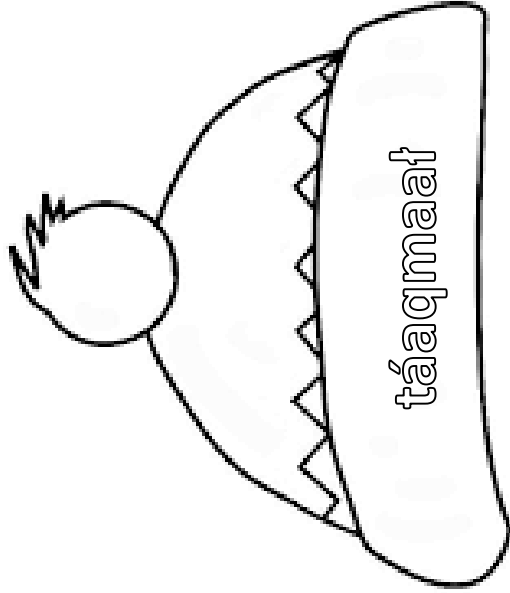

táaqmaat

w

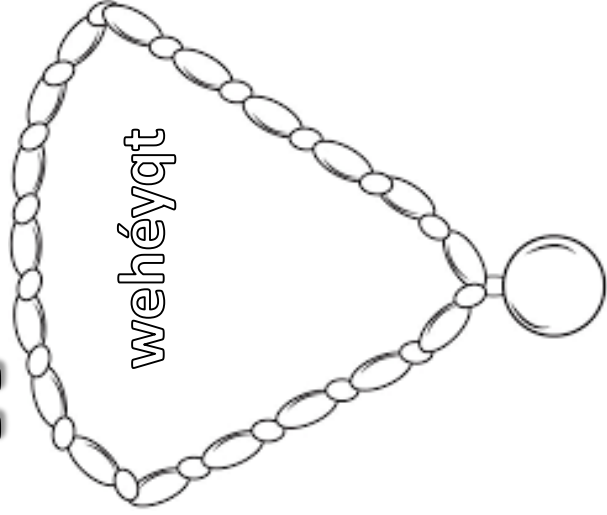

wehéyqt

S

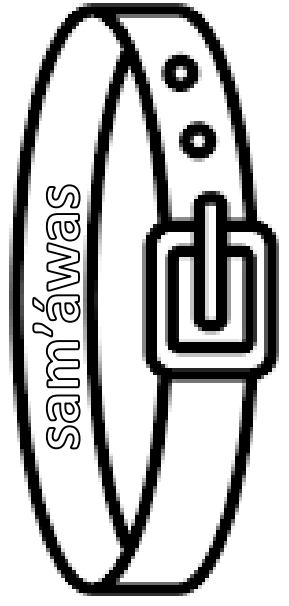

W

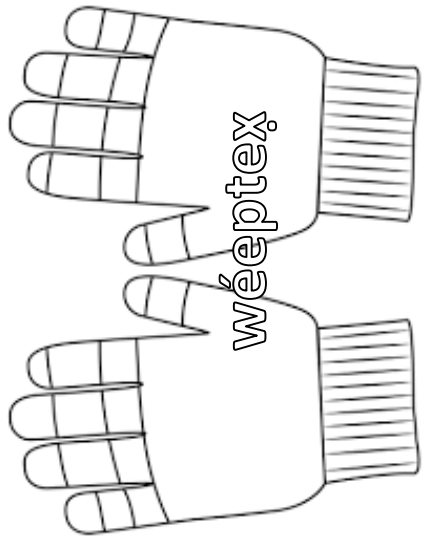

'i

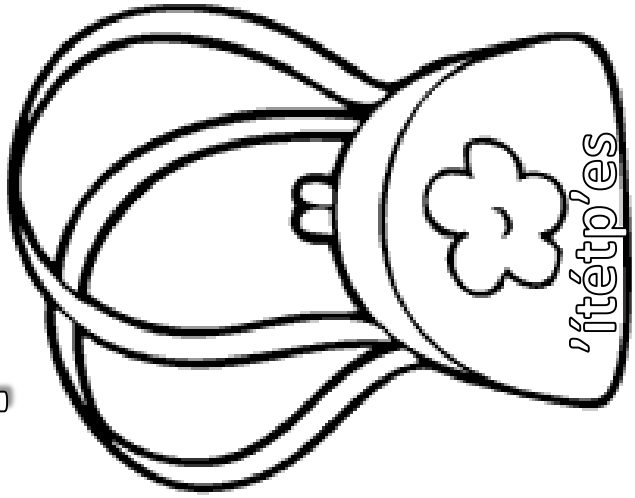

Y

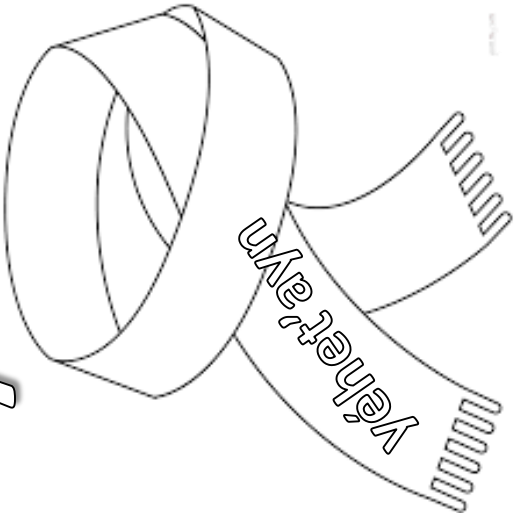

S

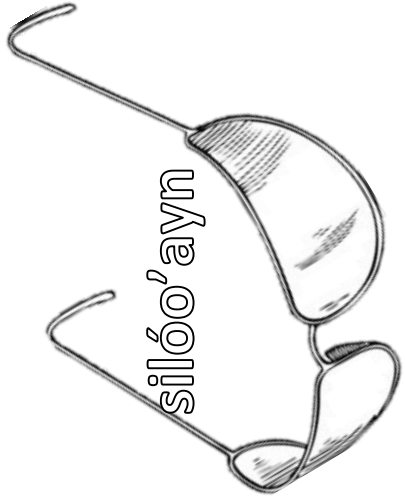

silóo'ayn

I

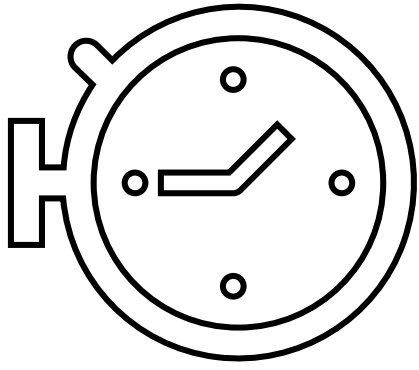

liklín'es

'i

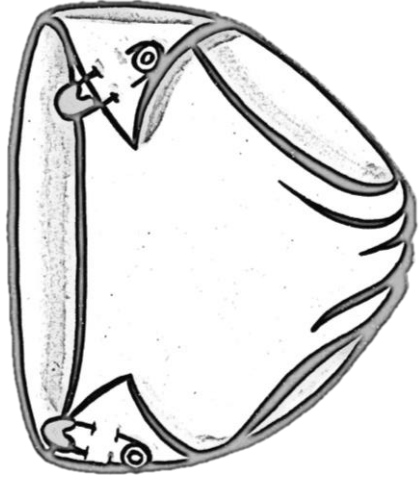

'ipáawtak'as

q

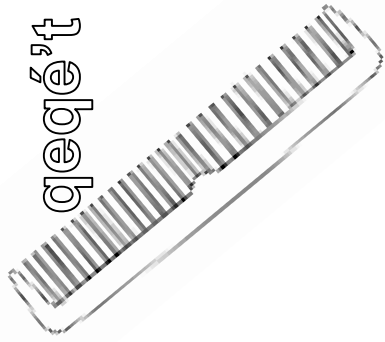

qeqé't



t

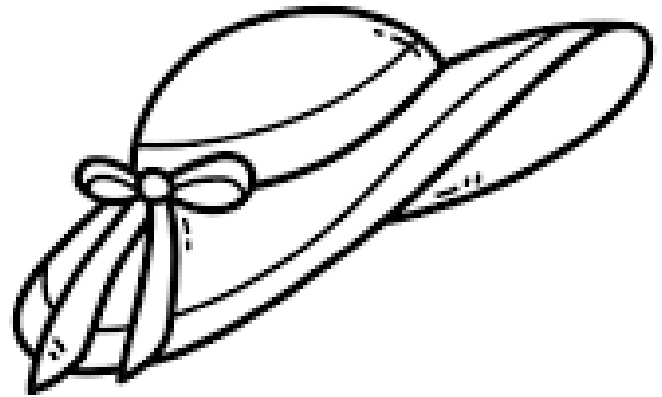

táaqaat

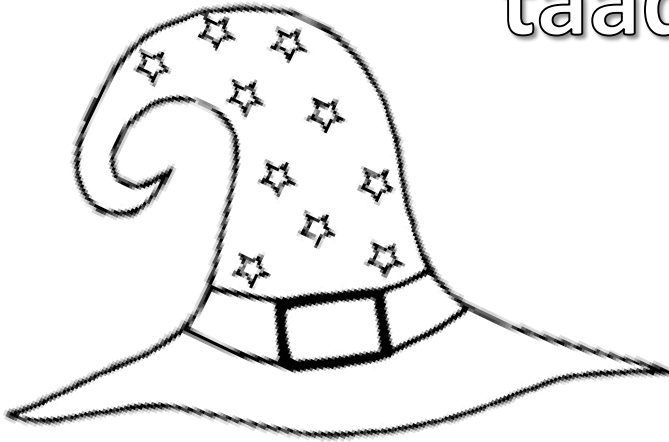

t

